



canfield
connector

Proportional ♦ Drivers ♦ Timers ♦ Electronics

TIMERS



canfield connector

www.canfieldconnector.com

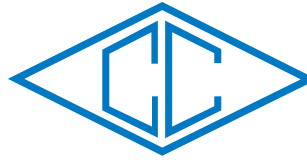

canfield connector

Quality is our goal.

Canfield Connector is a manufacturer of interconnection devices, electronic timers, modules and specialty electronic devices targeted at the fluid power industry. Our *Complete Quality Control Program (CQCP)* protects our customers by assuring them of 100% test and inspection prior to shipment of all items produced at Canfield Connector. Most items are tested during the manufacturing process and again during final inspection, making our products double or triple tested for function prior to shipment. Our Quality Policy at Canfield Industries is: Total Customer Satisfaction Through Unmatched Quality, Products, Service, and Integrity. Our Quality Objectives are Customer Satisfaction, On-Time Delivery, Sales and Profit Growth, High Quality Products, and Superior Supplier Performance. Canfield Connector operations have been certified to the ISO 9001 With Design International Quality System Standard.

1 year warranty

All products manufactured by Canfield Connector are warranted by Canfield Connector to be free of defects in material and workmanship for a period of one year from the purchase date. Canfield Connector's obligation under this warranty is limited to repair or replacement of the defective product or refund of the purchase price paid solely at the discretion of Canfield Connector and provided such defective product is returned to Canfield Connector freight prepaid and upon examination by Canfield Connector such product is found defective. This warranty shall be void in the event that the product has been subject to misuse, misapplication, improper maintenance, or tampering. This warranty is expressed in lieu of all other warranties, expressed or implied from Canfield Connector representatives or employees.

Designs and published data

All designs and specifications are subject to change without notice. Such changes are not to be considered retroactive, and seller assumes no responsibility for revision of models already in the field. All data is sufficiently accurate for general use, but seller assumes no responsibility for errors or omissions. Certified prints are available on request, at a reasonable charge.



Technical assistance

Our trained technical staff is available to help you with your questions concerning Canfield products. All questions are welcome. We are constantly developing new product lines and custom products for different applications. Ask our sales representative for more details. Call: (330) 758-8299 or 1-800-554-5071 Email: customerservice@canfieldconnector.com

Ordering made easy

Our friendly Customer Service Team is available to take your order 8:00 AM to 5:00 PM EST Monday through Friday. Call: (330)758-8299 or Toll Free: 1-800-554-5071 Fax: (330)758-8912 Email: customerservice@canfieldconnector.com



Youngstown, Ohio U.S.A.

DISCLAIMER

Product changes including specifications, features, designs, and availability are subject to change anytime without notice. For critical dimensions or specifications, contact factory.



Canfield Connector

8510 Foxwood Court • Youngstown, OH 44514

STANDARD TERMS OF SALE AND RESTOCKING

1. GENERAL:

- This contract contains the entire agreement between parties and supersedes any prior or contemporaneous oral or written agreements or communications between them relating to the subject matter hereof.
- This contract may not be assigned, modified or cancelled without Seller's prior written consent, and any attempt to assign, modify or cancel it without consent shall be absolutely void.
- No delay or omission to exercise any right, per or remedy accruing to Seller upon breach or default by Buyer under this contract shall impair any such right, power or remedy of Seller, or shall be construed as a waiver of any such breach or default. All waivers must be in writing.
- In the event of any of the provisions hereof shall, for any reason, be held void or unenforceable, the remaining provisions shall remain in full force and effect and shall control.
- Any provisions of this contract prohibited by law of any state shall as to said state, be ineffective to the extent of such prohibition without invalidating the remaining provisions of this contract.
- This contract shall be governed by and construed in accordance with the laws of the State of Ohio, excluding however, Ohio law pertaining to conflicts of law.

2. SELLER'S LIMITED WARRANTY AND LIMITATIONS OF LIABILITIES:

All goods sold hereunder are warranted to be free from defects in material and workmanship for a period of one (1) year from the date of manufacture unless otherwise agreed upon in writing, and to conform to applicable specifications, drawings, blueprints and/or samples. These express warranties are in lieu of and exclude all other warranties, express or implied. Seller's sole obligation under these warranties shall be to issue credit, repair, or replace any item or part thereof which is proved to be other than as warranted; no allowance shall be made for any labor charges of Buyer for replacement of parts, adjustment or repairs, or any other work, unless such charges are authorized in advance by Seller. If goods are claimed to be defective in material or workmanship or not to conform to specifications, drawings, blueprints and/or samples, Seller upon notice promptly given will either examine the goods at their site, or issue shipping instructions for return to Seller (transportation costs prepaid by Buyer). In the event any goods are proved to be other than as warranted, transportation costs to and from Seller's plant will be borne by Seller and reimbursement or credit will be made for amounts so expended by Buyer. In particular, seller makes no warranty respecting the merchantability of the products or their suitability or fitness for any particular purpose or use or respecting infringement. These warranties shall not extend to any goods or parts thereof which have been subjected to misuse or neglect, damage by accident, rendered defective by reason of improper installation or by the performance of repairs or alterations outside of Seller's plant except when performed under Seller's specific authority. These warranties shall not apply to any goods or parts thereof furnished by Buyer or acquired from others at Buyer's request and/or to Buyer's specifications. BUYER SHALL NOT IN ANY EVENT BE ENTITLED TO, AND SELLER SHALL NOT BE LIABLE FOR INDIRECT, SPECIAL, INCIDENTAL OR CONSEQUENTIAL DAMAGES OF ANY NATURE INCLUDING, WITHOUT BEING LIMITED TO, LOSS OF PROFIT, LOSS OF DATA, LOSS OF USE, PROMOTIONAL OR MANUFACTURING EXPENSES, OVERHEAD, INJURY TO REPUTATION OR LOSS OF CUSTOMERS. BUYER'S RECOVERY FROM SELLER FOR ANY CLAIM SHALL NOT EXCEED BUYER'S PURCHASE PRICE FOR THE PRODUCTS IRRESPECTIVE OF THE NATURE OF THE CLAIM, WHETHER IN CONTRACT, TORT, WARRANTY, OR OTHERWISE.

3. PAYMENT:

- Checks are accepted subject to collection and the date of collection shall be deemed the date of payment. Any check received from Buyer may be applied by Seller against any obligation owing by Buyer to Seller, under this or any other contract, regardless of any statement appearing on or referring to such check, without discharging Buyer's liability for any additional amounts owing by Buyer to Seller; and the acceptance by Seller of such check shall not constitute a waiver of Seller's right to pursue the collection of any remaining balance.
- On any invoice not paid by maturity date (net thirty (30) days), Buyer shall pay interest from maturity to date of payment at the annual percentage rate of 18% (or such lower rate as may be the maximum allowable by law), together with Seller's costs of collection (including reasonable attorneys' fees).
- Buyer agrees to pay the entire net amount of each invoice rendered by Seller pursuant to the terms of each such invoice without offset or deduction.
- Prices for any undeliverable Products may be increased by Seller in the event of any increase in Seller's cost of supplies, raw materials, labor or services, or any increase in Seller's cost resulting from government action or other cause beyond Seller's control.

4. CREDIT:

Seller may in its sole discretion at any time and from time to time change the terms of Buyer's credit, require payment in cash before shipment of any or all of the Products specified herein, and/or require anticipated payment of any or all amounts due or to become due under this contract. If Seller believes in good faith that Buyer's ability to make payments called for by this contract is or may be impaired, Seller may cancel this contract or any remaining balance thereof, Buyer remaining liable to pay for any Products already shipped.

5. TAXES/FREIGHT:

Unless otherwise agreed in writing, the amount of all transportation charges from Seller's location and all taxes or other charges now or hereafter imposed by any government authority upon sale, purchase, resale, delivery, manufacture, production or possession of the Products specified herein, which may be paid by Seller or for which Seller may be liable, shall be paid to Seller by Buyer in addition to the purchase price of the Products.

6. ORDERS:

- Each order for Products is subject to acceptance in writing by Seller.
- Orders may not be cancelled or rescheduled after delivery by Seller to the carrier. In the event of allocation of Products, orders that are accepted by Seller will be accepted using a fair schedule method.
- Special Orders - Special orders for items not normally stocked are non-cancelable and non-returnable.

7. DELIVERIES/TITLE:

- All goods shall be packed in suitable containers for protection in shipment and storage. No special charges for packing or crating shall be made unless specifically listed as an additional and separate charge on Seller's quotation or acceptance of Buyer's order.
- Subject to Seller's right of stoppage in transit, delivery of the Products to a carrier shall constitute delivery to Buyer, and risk of loss shall thereupon pass to Buyer; however, title shall remain in Seller until Buyer makes payment in full under contract. Products invoiced and held by Seller for any reason shall be at Buyer's risk and expense. Delivery route shall be the election of Seller unless specifically designated by Buyer.

- Delivery of any installment of Products within 30 days after the date specified therefor shall constitute a timely delivery. Thereafter, delivery shall be deemed timely unless prior to shipment Seller has received written notice of cancellation. Delivery of a quantity which does not vary by more than 10% from the quantity specified therefor shall constitute full performance of such delivery. Delay in delivery of one installment shall entitle Buyer to cancel that installment only.
- Should delivery of all or part of the Products specified herein (or any other obligation of Seller) be delayed by events beyond Seller's control, Seller's time for performance shall be extended by the period of delay, or Seller may, at its option, cancel this contract without liability, Buyer remaining liable for shipments already made. Sellers shall not be liable for any delays in or failures of delivery due to acts of God or public authority, labor disturbances, accidents, fires, floods, extreme weather conditions, failures of and delays by carriers, shortages of material, delays of a supplier due to causes beyond its control.
- Buyer is deemed to have accepted the Products unless notice of rejection is given within a reasonable time, which is agreed to be within seven (7) days after receipt. Buyer waives any right to revoke acceptance thereafter.
- No return of Products will be accepted by Seller without a return materials authorization number (RMA#), which will be issued in Seller's sole discretion. Returned Products must be in original shipping cartons, and must be freight prepaid. In the event any goods are proved to be other than as warranted, transportation costs to and from Seller's plant will be borne by Seller and reimbursement or credit will be made for amounts so expended by Buyer. Notice of defective Products must be made within seven (7) calendar days of receipt. A complete description regarding the nature of the defect must be included with all returned Products. All items not eligible for credit will be returned to Buyer, transportation collect.

8. SPECIFICATIONS AND DESIGNS:

- Should Buyer request that changes be made in the specifications or design relating to any goods, delivery dates and schedules shall be revised accordingly, if necessary, and an equitable adjustment, upward or downward, shall be made in price in so far as warranted.
- Any designs, tools, patterns, material, drawings, information or equipment furnished by Buyer, or any special tools made or acquired for the Buyer by the Seller which becomes Buyer's property, shall be used only in the production of the goods called for herein and not otherwise, unless by Buyer's written consent. Seller agrees to exercise reasonable care with respect to such property and equipment while in its possession and control, but shall not be responsible for loss or damage occurring without its fault or negligence or for ordinary wear and tear.

9. USE OF PRODUCTS:

- If technical advice is offered or given in connection with the use of any Products it will be as an accommodation to Buyer and without charge and Seller shall have no responsibilities or liabilities whatsoever for the content or use of such advice.
- Products sold by Seller are not designed for use in life support or nuclear applications. Seller's customers using or selling Products for use in life support or nuclear applications do so at their own risk, agree that Seller and the Manufacturer of Products are not liable, in whole or in part, for any claim or damage arising from such use, and agree to fully indemnify Seller and the Manufacturer from and against any and all damages, loss, cost, expense or liability arising out of or in connection with the use or performance of Products in life support or nuclear applications.
- Should the Buyer notify the Seller that its order is placed under a prime contract with an agency of the United States Government, the following terms and conditions shall be incorporated into Seller's terms of sale in so far as the Buyer is required to incorporate such provisions in its purchase orders or subcontracts of terms in so far as applicable to the goods sold hereunder.
- The following clause set forth or referred to in Sections 7 and 12 of the Armed Services Procurement Regulations are hereby incorporated by reference: Renegotiation (7-103.13), Eight Hour Law of 1912 (7-103.16 12-303.1), Walsh-Healy Public Contracts Act (7-103.17 12-604), Nondiscrimination in Employment (7-103.18 12-802), Officials Not to Benefit (7-103.19), Buy American Act (7-104.3 6-104.5), Notice to the Government of Labor Disputes (7-104.4), Excess Profit (7-104.11), Military Security Requirements (7-104.12), Examination of Records (7-104.15), Convict Labor (7-104.17 12-203). In order to make the context of the above clauses applicable to these terms of sale, the word "Buyer" shall be substituted for the word "Government" and the word "Seller" shall be substituted for the word "contractor" whenever necessary.
- Unless the design for the goods shall have been furnished by the Buyer to the Seller and used by the Seller in manufacturing the goods, Seller shall defend and save harmless the Buyer from any claim that any product or article sold to the Buyer hereunder in and of itself infringes any United States letters patent by reason of its sale or use/ provided Seller is notified in writing within ten (10) days after any such claim is made against the Buyer, and provided further that Seller is permitted to defend the same in Buyer's name if action be brought. If the product or article sold to the Buyer hereunder is manufactured by the Seller according to a design furnished by the Buyer, the Buyer will defend and save harmless the Seller from any claims of infringement of any United States Letters patent.

10. TOOLING:

Tool, die, and pattern charges, if any, are in addition to the price of the Goods and are due and payable upon completion of the tooling. All such tools, dies and patterns shall be and remain the property of Seller. Charges for tools, dies, and patterns do not convey to Buyer, title, ownership interest in, or rights to possession or removal, or prevent their use by Seller for other purchasers, except as otherwise expressly provided by Seller and Buyer in writing with reference to this provision.

11. INSTALLATION/TRAINING:

Buyer acknowledges that no installation, training or education is contracted for or purchased under terms of this contract unless specifically agreed in writing. In the event that Buyer receives any training from Seller with respect to the Products, then, in that event, such training is personal to the persons receiving such training, and Buyer acknowledges that any persons receiving such training may not be capable of operating the Products.

12. RESTOCKING POLICY:

Merchandise that is returned must be accompanied by pre-approved return materials authorization number (RMA#). Return authorizations will be approved by Canfield Connector. When materials are received, an inspection will be performed to determine if restocking charges are applicable. Material that does not have an authorization will be returned to the purchaser at their expense. RETURNED ITEMS MAY ENTAIL A RESTOCKING CHARGE. CONSULT FACTORY FOR EXACT RESTOCKING FEES. AS CHARGES MAY VARY DEPENDING ON THE AMOUNT OF SPECIALTY OF THE ITEMS BEING RETURNED. CUSTOM PARTS & "9-" NUMBERS ARE NON-RETURNABLE AND NON-REFUNDABLE (EXCEPT IN CASES OF WARRANTY)

Table of Contents

Proportional Drivers, Timers and Electronic Circuits

- 4** D5400 - Micro Solenoid Driver (MSD)
- 6** 5800 - Micro Logic Timer (MLT)
- 10** 5950 - Micro Proportional Driver (MPD)
- 12** B5950 - Block-Style Micro Proportional Driver
- 14** Sandwich CRT - Sandwich-Style Condensation Removal Timer
- 16** MBT - Multifunction Block Timer
- 20** TMLT - Micrologic Timer Module

Additional Information

- 24** Environmental Protection Classifications
- 25** Units and Conversions and OHMS Law
- 26** Glossary of Terms

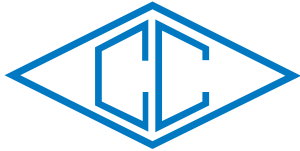

canfield connector
8510 Foxwood Court
Youngstown, Ohio 44514
P:(330) 758-8299 F:(330) 758-8912
www.canfieldconnector.com

D5400 SERIES Coil Saver®

MICRO SOLENOID DRIVER POWER CONVERTER

General Description

The Canfield Connector D5400 Series Micro Solenoid Driver is a NEMA 4 DIN Style "A" EN175301-803 (Formerly DIN 43650) and MINI type connector with a built in electronic circuit used to induce solenoid pull-in and reduce holding current. The time proven MSD has been designed into many applications where heat buildup occurs which reduces operating efficiency and life span of solenoid valves. The MSD has two main functions: one is to induce faster or stronger than usual response times at solenoid pull-in, the second is to reduce the net wattage of the solenoid during hold-in. The MSD drives the coil with a high input voltage for a fixed time period until the coil has shifted at which time the MSD reduces the holding voltage, which saves power, and the solenoid runs cool. The MSD Series is often used to replace low voltage power supplies where a 24 VDC solenoid valve can then be operated by 120 VAC. The Alternating current is rectified and the duty cycle reduced so as to operate the valve at proper voltage and wattage ranges. An additional advantage can be found when the MSD drops the holding voltage, which then reduces heat and current requirements.

Dimensional Data

ALL DIMENSIONS ARE IN MILLIMETERS UNLESS OTHERWISE NOTED



ISO, Lighted version
shown above

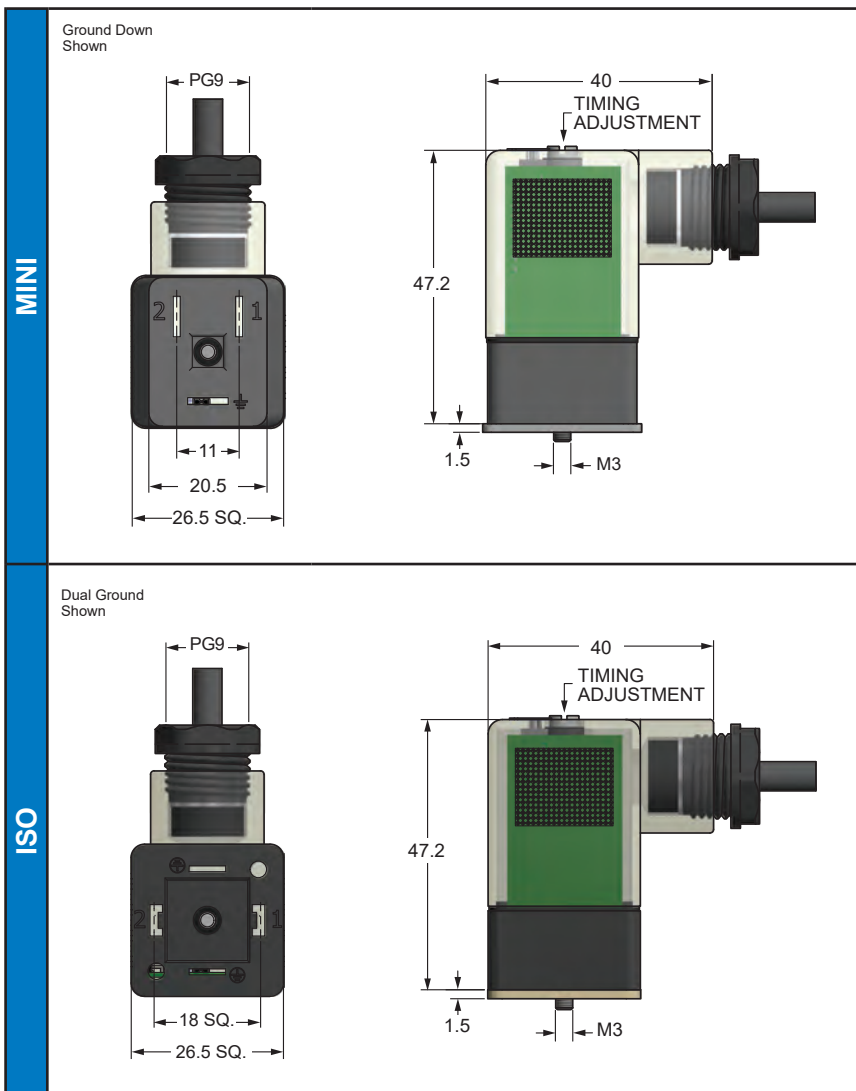

Technical Data

Output Current	Inrush: 8 Amps for 50 ms Holding: 1 Amp
Output Voltage	10% - 70% DC of Input
Input Voltage Max.	240 VAC, 24 VDC
Allowable Input Voltage DC	20% peak to peak
Materials	Housing: Nylon, Black; Translucent (lighted versions) Interface: Nylon, Black Gasket: Nitrile
Temp Range	-20° to +50°C
Gasket Temperature Max.	Nitrile: -25° to +90°C
Environmental Protection	NEMA 4
Cable Diameter	PG7 0.157" to 0.236" O.D. 1/2" Conduit 0.410" max.
Wire Gauge	20 AWG
Size	ISO: 18mm pin spacing - DIN Style "A" EN175301-803 MINI: 11mm pin spacing - Industry Standard
Number of Contacts	2+ ground

NOTE: Slight discoloration may occur to translucent material after prolonged exposure to UV rays.

Output Waveforms

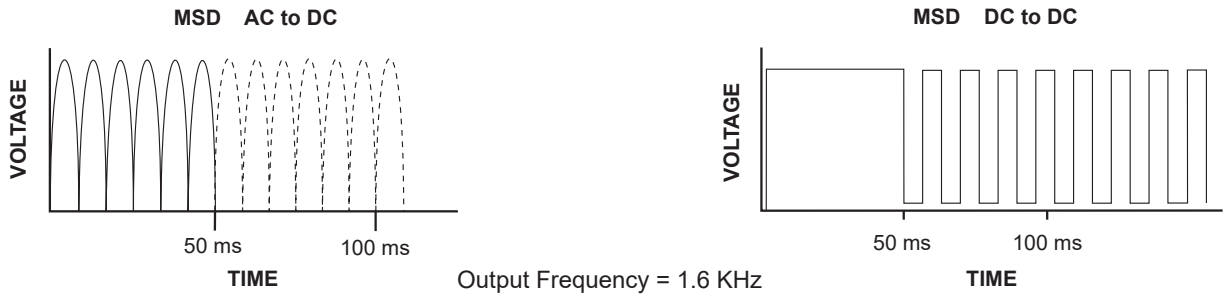

The MSD allows the input line voltage directly to the coil for a fixed single shot of 50 milliseconds. After that period, the MSD automatically pulses the input voltage to the coil. In either fixed or adjustable versions, the MSD turns the power on and off so fast that the armature does not respond. By adjusting the off period so that it is longer than the on period, the net RMS voltage decreases and wattage is decreased. Many coils can be adjusted much lower than expected due to the fact that much less energy is required for hold-in as opposed to pull-in.

Ordering Information

Each connector kit contains screw, washer and gasket assembly.

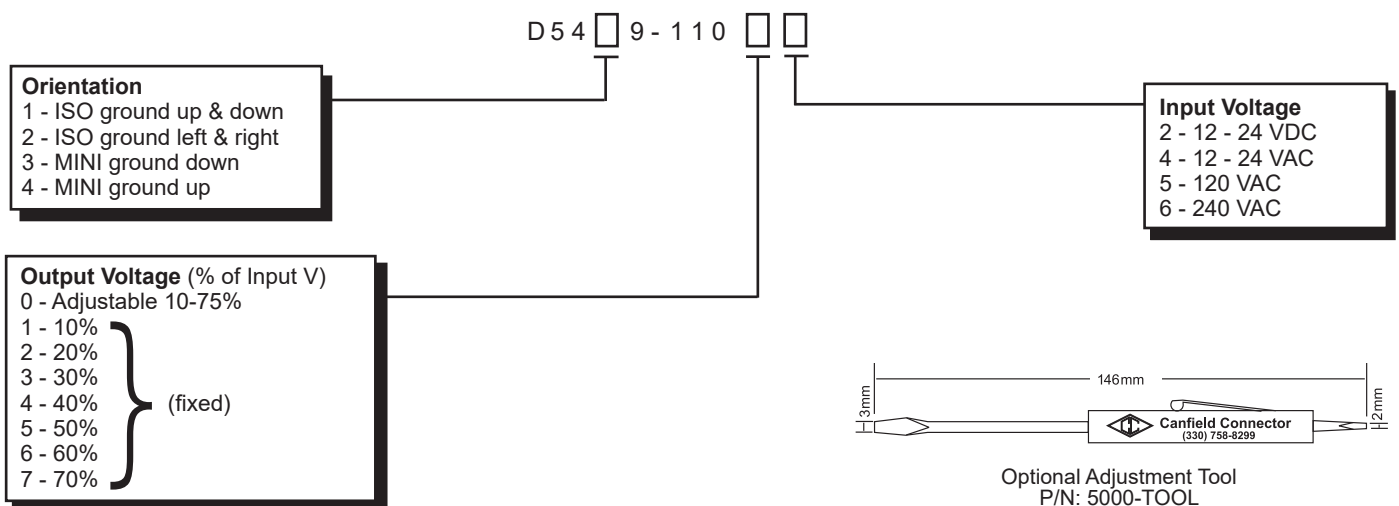

Ordering Example: D5439 - 11005

MINI ground down, Adjustable output, 120 VAC

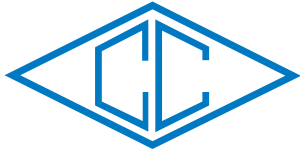

5800 SERIES

**MICRO LOGIC
 TIMER**

General Description

The Canfield Connector 5800 Series Micro Logic Timer is a solid state electronic timing unit incorporated inside the standard MINI and DIN Style "A" EN175301-803 (Formerly DIN 43650) electrical connectors. The MLT allows precise timing and logic functions in a small, easily mounted enclosure. There are eight standard timer types. Each timer incorporates circuitry for AC or DC operation with a wide voltage range.

Dimensional Data

ALL DIMENSIONS ARE IN MILLIMETERS UNLESS OTHERWISE NOTED



ISO, Lighted version shown above

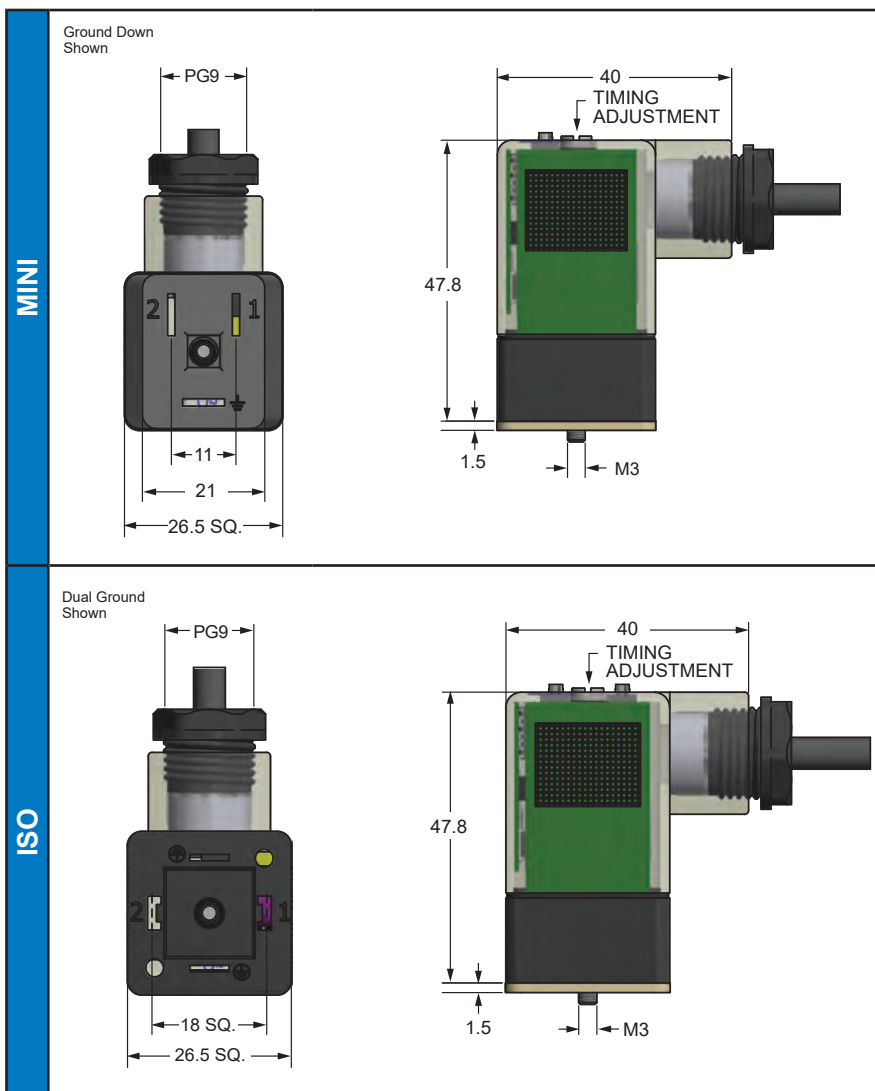

Consult factory for available versions listed by Canadian Standards Association for use with certified electrical equipment.

TIMER TYPE 1

Solenoid is energized for ΔT upon application of power. Reset occurs when power is removed.

Interval Delay/(One Shot)

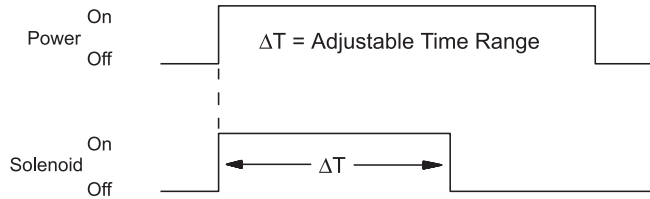

TIMER TYPE 2

Solenoid remains OFF for ΔT upon application of power. Reset occurs when power is removed.

On Delay/(Delay On Make)

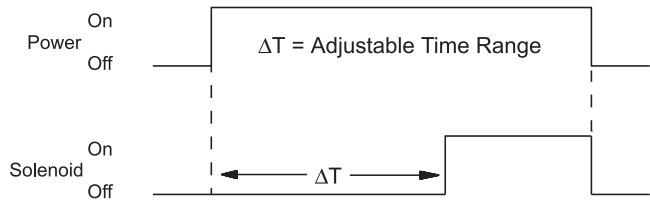

TIMER TYPE 3

When power is applied, solenoid remains OFF. Solenoid is energized for ΔT only upon closure of a normally open momentary contact switch (trigger). Reset occurs when solenoid is OFF and trigger is re-applied.

Off Delay/(Triggered One Shot)

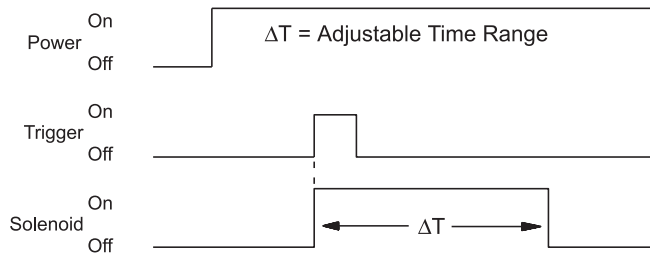

TIMER TYPE 4 / A

Solenoid cycles ΔT_1 OFF and ΔT_2 ON when power is applied. Reset occurs when power is removed. Timer is available in normally on (Type A) or normally off (Type 4) versions.

Cycle Timer

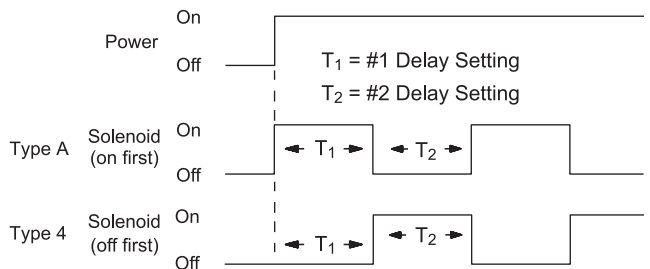

TIMER TYPE 5 / 9

Solenoid cycles with equal ON and OFF times when power is applied. Reset occurs when power is removed. Timer is available in normally on (Type 5) or normally off (Type 9) versions.

Square Wave Cycle Timer

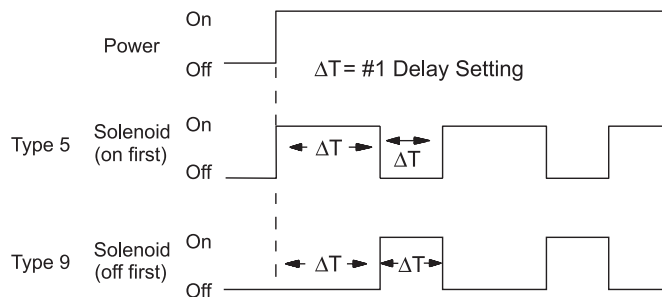

TIMER TYPE 6

When power is applied, solenoid remains OFF. Solenoid is energized for $\Delta T_c + \Delta T$ when trigger switch is closed and opened. Reset occurs when solenoid is OFF and trigger is re-applied.

Delay On Break Normally Off

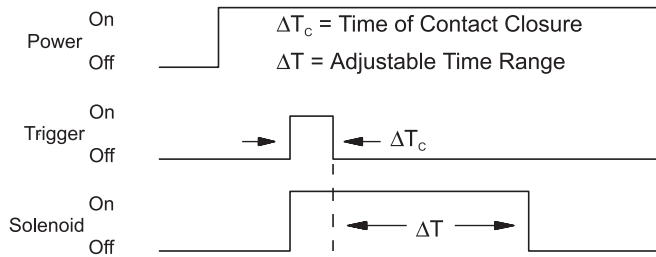

TIMER TYPE 7

When power is applied, solenoid is energized and remains energized until the trigger switch is closed. Solenoid is then OFF for $\Delta T_c + \Delta T$. Reset occurs when solenoid is ON and the trigger is re-applied.

Delay On Break Normally On

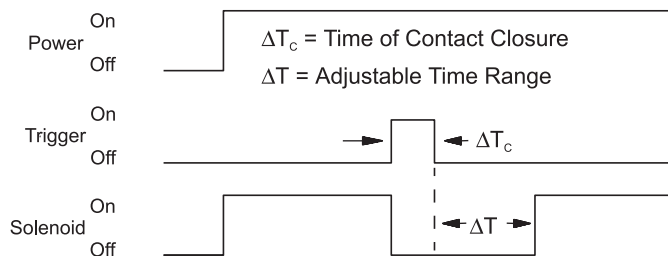

TIMER TYPE 8

When power is applied, the solenoid is energized. Solenoid de-energizes for ΔT only upon closure of a normally open momentary contact switch (trigger). Reset occurs when solenoid is ON and the trigger is re-applied.

Triggered One Shot Normally On

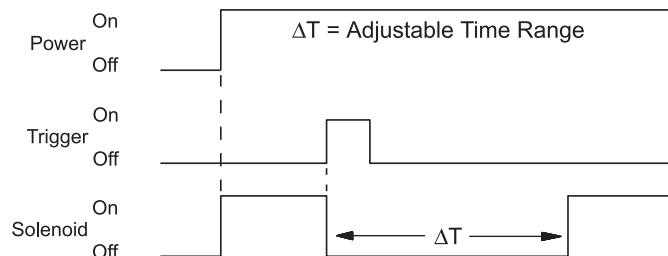

TIMER TYPE B / C

Solenoid cycles ΔT_1 OFF and ΔT_2 ON when power is applied. Reset occurs when power is removed. Timer is available in normally off (Type B) or normally on (Type C).

Single Cycle Timer

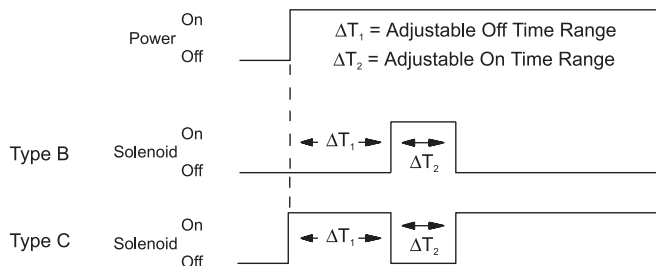

Technical Data

Input Voltage Range	12-240 VDC, 24-240 VAC (50/60 Hz)
Max. Input Voltage	Tolerance: +/-10%
Max. Output Current	1 Amp
Frequency	AC 50/60 Hz or DC
Time Ranges	0.1 sec. to 33 min.; Standard
Timer Repeat Accuracy	+/-0.5%; Under normal conditions
Surge Suppression	MOV
Materials	Housing: PC
Indicator Light	Red
Ambient Rated Temp.	-20° to +60°C
Environmental Protection	IP 65 and NEMA 4
Cable Diameter	0.240"
Cable Conductor Color	Brown, Green, White (Trigger; Yellow, Gray)
Cable Type	Pressure Extruded PVC Jacket
Wire Gauge	20 AWG; Standard
Wire Length	9ft.; Standard

NOTE: Slight discoloration may occur to translucent material after prolonged exposure to UV rays.

Ordering Information

Each kit contains all mounting hardware and gasket assembly..

5 8 □ □ - 9 1 0 □ 3

Timer Type

- 1 - Interval delay / One shot
- 2 - On delay / Delay on make
- 3 - Off delay / Triggered one shot
- 4 - Cycle timer / Normally off
- 5 - Square wave cycle timer / Normally on
- 6 - Delay on break / Normally off
- 7 - Delay on break / Normally on
- 8 - Triggered one shot / Normally on
- 9 - Square wave cycle timer / Normally off
- A - Cycle timer / Normally on
- B - Single cycle timer / Normally off
- C - Single cycle timer / Normally on

Period Delay

- A - 0.5 to 5 seconds
- B - 0.5 to 25 seconds
- C - 0.5 to 50 seconds
- D - 0.5 to 100 seconds
- E - 2.0 to 20 seconds
- F - 2.0 to 200 seconds
- G - 2.0 to 400 seconds
- H - 5.0 to 50 seconds
- I - 5.0 to 500 seconds
- J - 10.0 to 100 seconds
- K - 10.0 to 1000 seconds
- L - 10.0 to 2000 seconds
- Z - 0.1 to 5 seconds

Custom time ranges available. please contact factory

Connector Orientation

- 1 - ISO ground up & down
- 2 - ISO ground right & left
- 3 - MINI ground down
- 4 - MINI ground up

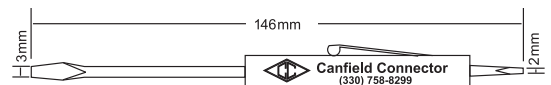

Optional Adjustment Tool
P/N: 5000-TOOL

Ordering Example: 5811-910A3

Interval Delay, ISO ground up & down,
0.5 to 5 second delay

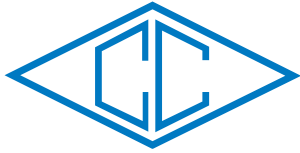

canfield connector
8510 Foxwood Court
Youngstown, Ohio 44514
P:(330) 758-8299 F:(330) 758-8912
www.canfieldconnector.com

5950 SERIES

MICRO PROPORTIONAL DRIVER

General Description

A Micro Proportional Driver provides accurate control of hydraulic and pneumatic proportional solenoid valves used in mobile construction equipment and industrial processes. The MPD can control the flow of air or liquid linearly at a setting from 0.10-20 seconds. One example of use would be in a paint system. The MPD allows a solenoid to oscillate, significantly reducing system shock and wear commonly found in non-oscillation digital valve systems. The Micro Proportional Driver is a compact electronic circuit built into an environment-resistant miniaturized enclosure. The circuit features control of proportional solenoids and operators. Functions include minimum and maximum current limiting, control signals from 0-10V or 0-20 mA (with a step function at 0.2V or 0.4 mA included for minimum current), a 0.1-20 sec. linear ramp up/ramp down adjustment and output current proportional to input command signal.

Dimensional Data

ALL DIMENSIONS ARE IN MILLIMETERS UNLESS OTHERWISE NOTED

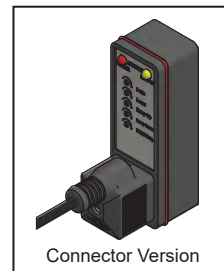

Connector Version

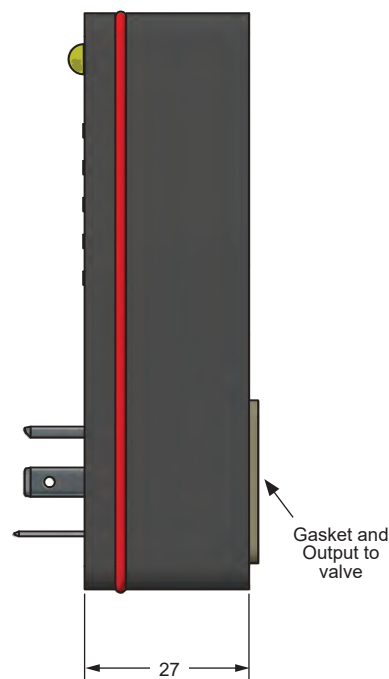
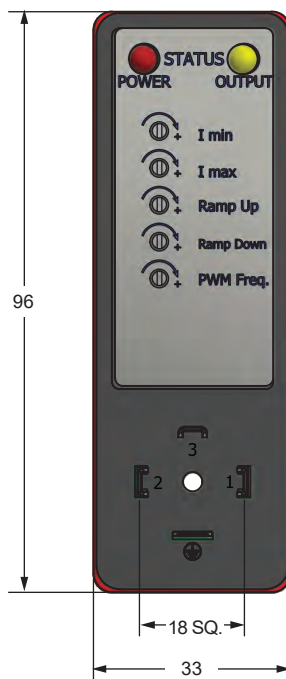

Technical Data

Output Current @ 25° C_A Continuous Peak Pulsed (16ms) I min. (+/- 20%) I min. (+/- 20%)	High Resolution Version: 1.5 Amps max. 4.7 Amps max. 0 - 0.5 Amps max. I min. + 1.0 Amps max.	High Output Version: 3.0 Amps max. 17.0 Amps max. 0 - 1.0 Amps max. I min. + 2.0 Amps max.
Supply Voltage	11.5 VDC min. - 32 VDC max.	
Supply Current	45 mA max. (no load)	
Input Control Signal Control Voltage Control Current Regulation ΔV Regulation ΔT Ramping Up/Down Time PWM Frequency Output Leap to I min.	0 - 10 VDC (500 Ω impedance) 0 - 20 mA (100 Ω impedance) +/- 0.2% / V +/- 0.1% / °C 0.1 - 20 sec. linear (+/- 0.1% / °C) 95 - 225 Hz @ 0.2 V or 0.4 mA control (+/- 15%)	
Temperature Range	-25° to +85°C	
Materials	Housing: PA	
Environmental Protection	IP 65 and NEMA 4 (When properly installed)	
Size	ISO: 18mm pin spacing - DIN Style "A" EN175301-803	

Function

Minimum Current & Maximum Current - These two adjustments will vary the minimum and maximum output current limits. The minimum current can be set between 0 - 500 mA or 0 - 1 A, depending on output current option. The maximum current can be set in the range between the minimum current setting and the minimum current setting plus 1 A or 2 A, depending on output current option. The minimum current must be set first as described below.

Minimum Current Adjustment - Set both min. and max. current adjusters max. counterclockwise. Apply an input command signal of approximately 0.5 volts or 1.0 mA. Adjust the min. current adjuster for a minimum current or to a desired system response. Back up adjuster until system stops responding. Proceed to max. current adjuster.

Maximum Current Adjustment - Increase the input command signal to 10 volts or 20 mA. Adjust max. current adjuster for a maximum current limit or to a desired system response.

Note: To minimize any effect of supply voltage, load resistance or temperature variation, make setup adjustments when these

parameters are at the midpoint of the expected operating range for a particular installation. For example, if the expected operating temperature range is 20° C to 60° C, make final setup adjustments when system is approximately 40° C. If the supply voltage has a tolerance of 22 to 32 volts, make adjustments when the supply voltage is approximately 27 VDC.

Ramp Up/Ramp Down - Adjust to desired ramp up/ramp down time (0.10 - 20 sec.). Ramp time is linear and is proportional to the step change in the control signal. For example: 0.2 - 10 VDC change in control signal gives max. ramp of 20 sec. 0.2-5 VDC change in control signal gives max. ramp of 10 sec.

PWM Frequency - The output is pulse-width modulated to control output current within the minimum and maximum current settings. The frequency of the modulation is continuously adjustable from 95 - 225 Hz.

Output - The output is current regulated and will remain constant (within the limits specified under Technical Data on previous page) at the level set by the input command signal. Variations in supply voltage and load resistance have little effect as long as these values satisfy the equality stated below.

$$\text{Maximum Required Currents} \leq \frac{\text{Min. Supply Voltage}}{\text{Max. Load Resistance}}$$

Ordering Information

Contains gasket and mounting screw.

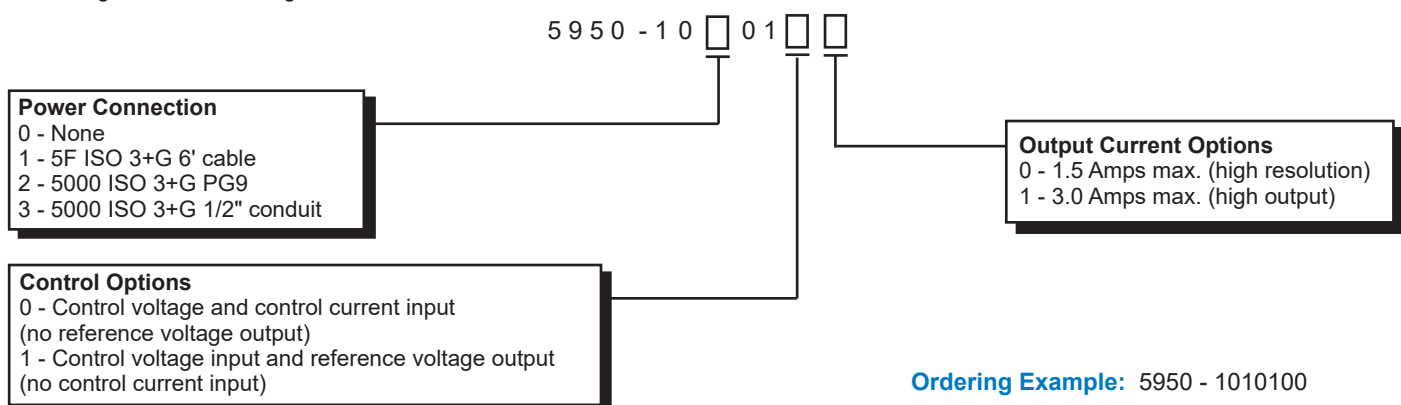

Ordering Example: 5950 - 1010100

5F ISO 3+G 6' cable, control voltage and control current input, 1.5 amps max. output

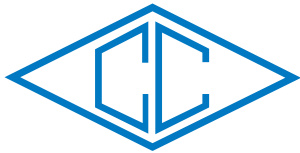

canfield connector
 8510 Foxwood Court
 Youngstown, Ohio 44514
 P:(330) 758-8299 F:(330) 758-8912
 www.canfieldconnector.com

B5950 SERIES

BLOCK MICRO PROPORTIONAL DRIVER

General Description

The Canfield Connector B5950 Series is a rugged proportional driver built into an epoxy potted enclosure designed to control linear proportional solenoid operators. Features include selectable control signal inputs from 0-5V or 0-20 mA with adjustable min/max current output. The output steps to the minimum current setting when 0.1V or 0.4 mA is applied to the control signal input. Also included in the compact package is a 0.1 to 20 second adjustable ramp-up and ramp-down output and sine wave dithering (PWM) with adjustable amplitude and frequency. The B5950 has an output current that is proportional to the command signal input.

Dimensional Data

ALL DIMENSIONS ARE IN MILLIMETERS UNLESS OTHERWISE NOTED

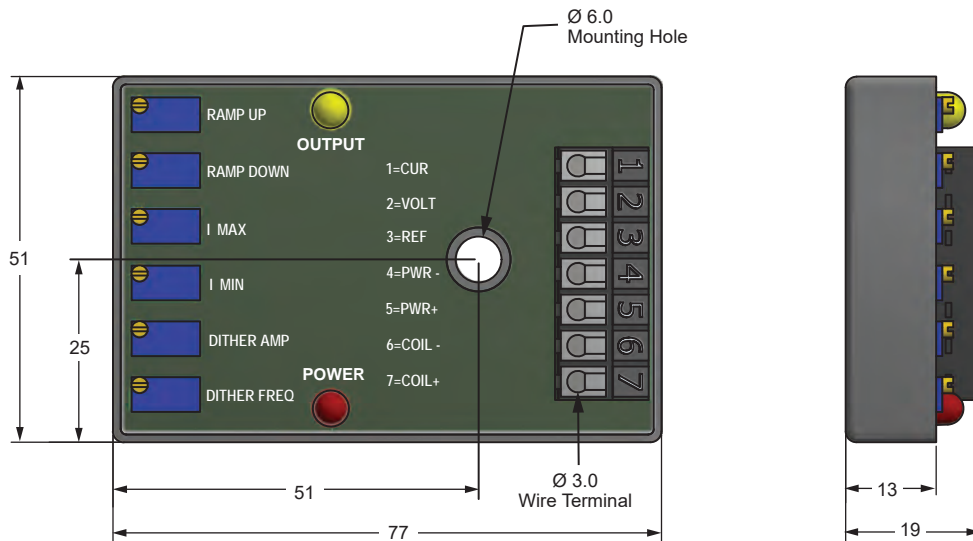

Technical Data

Output Current @ 25° C_T Continuous Peak Pulsed (16ms) I min. (+/- 20%) I min. (+/- 20%)	High Resolution Version: 1.5 Amps max. 4.7 Amps max. 0 - 0.5 Amps max. I min. + 1.0 Amps max.	High Output Version: 3.0 Amps max. 17.0 Amps max. 0 - 1.0 Amps max. I min. + 2.0 Amps max.
Supply Voltage	9 VDC min. - 32 VDC max.	
Supply Current	45 mA max. (no load)	
Input Control Signal Control Voltage Control Current Regulation Δ V Regulation Δ T Ramping Up/Down Time PWM Frequency Output Leap to I min.	0 - 5 VDC (300 Ω impedance) 0 - 20 mA (100 Ω impedance) +/- 0.2% / V +/- 0.1% / °C 0.1 - 20 sec. linear (+/- 0.1% / °C) 1.2 Hz Fixed @ 0.1 V or 0.4 mA control (+/- 15%)	
Dithering Frequency	30-150 Hz	
Dithering Amplitude	0-500 mA Peak to Peak	
Voltage Reference	5.0V +/-5% Regulated	
Temperature Range	-25° to +85°C	
Materials	Housing: ABS Encapsulation: Epoxy	

Function

Minimum Current & Maximum Current - These two adjustments will vary the minimum and maximum output current limits. The minimum current can be set between 0 - 500 mA or 0 - 3 A, depending on output current option. The maximum current can be set in the range between the minimum current setting and the minimum current setting plus 1 A or 2 A depending on output current option. The minimum current must be set first as described below.

Minimum Current Adjustment - Set both min. and max. current adjusters max. counterclockwise. Apply the minimum input command signal (approximately 0.5 volts or 1.0 mA). Adjust the min. current adjuster for a minimum current or to a desired system response. Back up adjuster until system stops responding. Proceed to max. current adjuster.

Maximum Current Adjustment - Increase the input command signal to maximum. Adjust max. current adjuster for a maximum current limit or to a desired system response.

Note: To minimize any effect of supply voltage, load resistance or temperature variation, make setup adjustments when these parameters are at the midpoint of the expected operating range for a particular installation. For example, if the expected operating temperature range is 20° C to 60° C, make final setup adjustments when system is approximately 40° C. If the supply voltage has a tolerance of 22 to 32 volts, make adjustments when the supply voltage is approximately 27 VDC.

$$\text{Maximum Required Currents} \leq \frac{\text{Min. Supply Voltage}}{\text{Max. Load Resistance}}$$

Ramp Up/Ramp Down - Adjust to desired ramp up/ramp down time (0.10 - 20 sec.). Ramp time is linear and is proportional to the step change in the control signal. For example: 0.1 - 5 VDC change in control signal gives max. ramp of 20 sec. 0.1 - 2.5 VDC change in control signal gives max. ramp of 10 sec.

PWM Frequency - The output is pulse-width modulated to control output current within the minimum and maximum current settings. The frequency of the modulation is fixed at 1.2 KHz.

Dither - The coil current is sine wave modulated with adjustable frequency (30 - 150 Hz) and amplitude (0 - .5A peak to peak).

Reference Voltage - A regulated 5.0 VDC voltage is available for on site command voltage. Use of a 10K - 100K potentiometer connected from 5.0 VDC Reference to Supply Voltage (-) is recommended.

Output - The output is current regulated and will remain constant (within the limits specified under Technical Data on previous page) at the level set by the input command signal. Variations in supply voltage and load resistance have little effect as long as these values satisfy the equality stated below.

Ordering Information

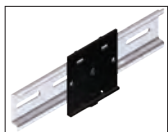
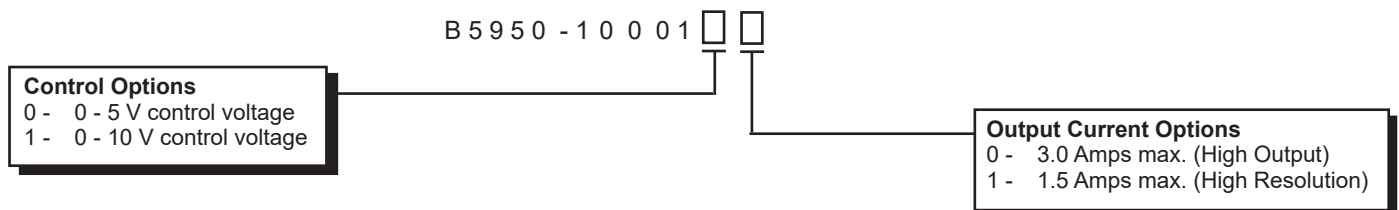

DIN Rail Mounting Adapter
P/N: DRM-100

Ordering Example: B5950 - 1000100

Block Micro Proportional Driver, 0-5V control voltage, 3.0 Amps max

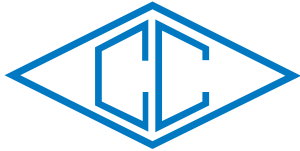

canfield connector
8510 Foxwood Court
Youngstown, Ohio 44514
P:(330) 758-8299 F:(330) 758-8912
www.canfieldconnector.com

SANDWICH CRT

CONDENSATION REMOVAL TIMER

General Description

This Canfield Connector miniature timer makes any valve, with the DIN Style "A" EN175301-803 (Formerly DIN 43650) electrical interface, able to operate as a compressed air system condensate removal valve. The unit installs in a modular form between an existing coil and connector. No new wiring is necessary. Retrofits on virtually any installation. It works with the valve brand of your choice. The cycle and on times are easily adjustable and two indicator lights show status.

Dimensional Data

ALL DIMENSIONS ARE IN MILLIMETERS UNLESS OTHERWISE NOTED

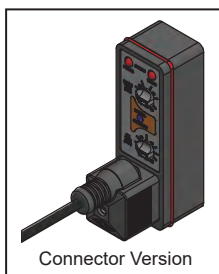

Connector Version

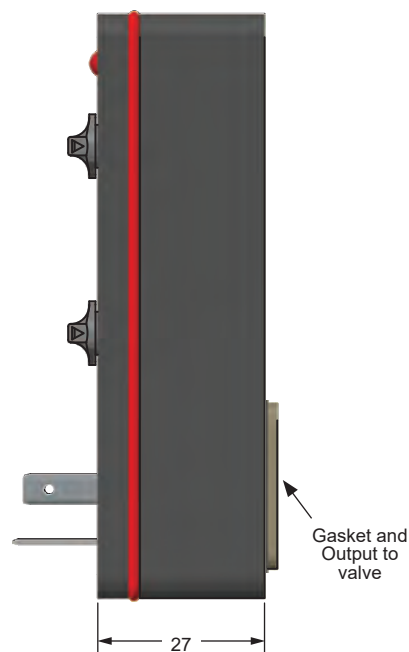
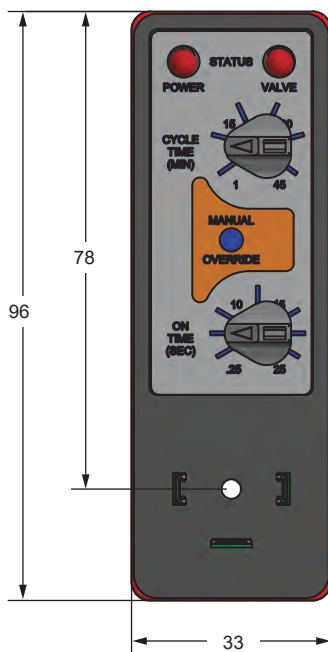

Gasket and
Output to
valve



Consult factory for available versions listed by Canadian Standards Association for use with certified electrical equipment.

Timer Function

TIMER FUNCTION

Upon application of power to the input terminals, the OFF time is initiated. At the end of the preset CYCLE time, the solenoid is energized and the ON time begins. At the end of the preset ON time, power is removed from the solenoid and a new cycle begins. Cycling continues until power is removed from the input terminals.

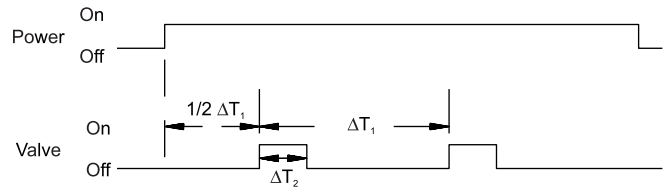

ΔT_1 = Cycle Rate (1 min. to 45 min.)
 ΔT_2 = Valve ON Time (.25 sec. to 25 sec.)

Technical Data

Voltage Range	12-60 VDC, 12-240 VAC 50/60 Hz
Max. Output Current	1 Amp AC, 1Amp DC
Transient Suppression	AC - MOV DC - Diode
Materials	Housing: PA
Temp. Range	-20° to +65°C
Environmental Protection	IP 65 and NEMA 4 (When properly installed)
Size	ISO: 18mm pin spacing - DIN Style "A" EN175301-803

Ordering Information

Contains gasket and mounting screw.

5 9 4 0 - 0 0 0

Power Connection

- 0 - None
- 1 - 5F ISO 2+G 6' cable with 120V plug
- 2 - 5000 ISO 2+G 1/2" conduit
- 3 - 5F ISO 2+G 6' cable

Voltage Range

- 2 - 12 - 60 VDC
- 4 - 12 - 120 VAC
- 5 - 120 - 240 VAC

Ordering Example: 5940 - 10005
 Sandwich Timer (CRT), 5F ISO 2+G
 6' cable, 120 to 240 VAC

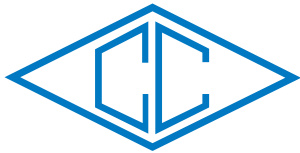

MBT

MULTIFUNCTION BLOCK TIMER
12 FUNCTIONS IN 1 TIMER

General Description

The Canfield Connector model MBT Multifunction Block Timer is designed as a full featured, multiple voltage, all-in-one programmable timer. It can be operated individually or cascaded to perform virtually any timing sequence desired. The unit has a time range adjustable from 0.1 seconds to 33.3 hours. Features include twelve modes of operation including a multitude of logic function possibilities and an indicator light for fast troubleshooting along with single turn timing adjustment. The MBT can instantly handle all mobile, industrial and automation applications right off the shelf.

Dimensional Data

ALL DIMENSIONS ARE IN MILLIMETERS UNLESS OTHERWISE NOTED

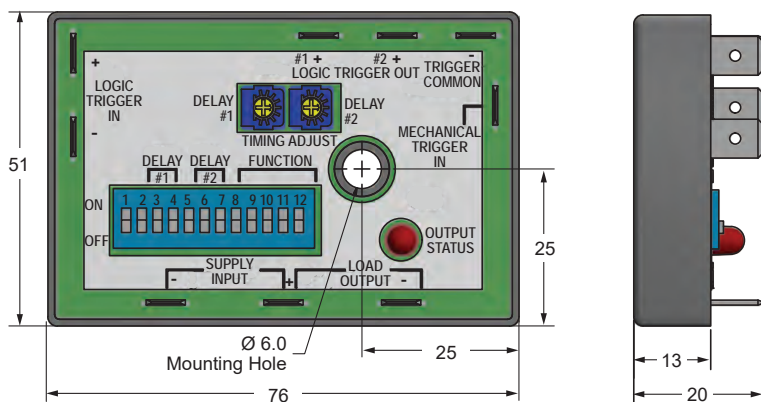
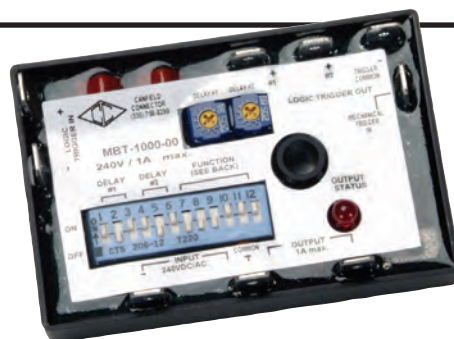

Hook-Up

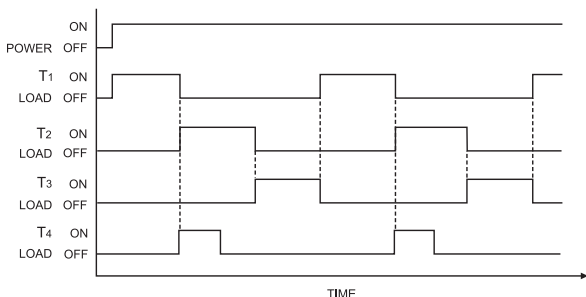
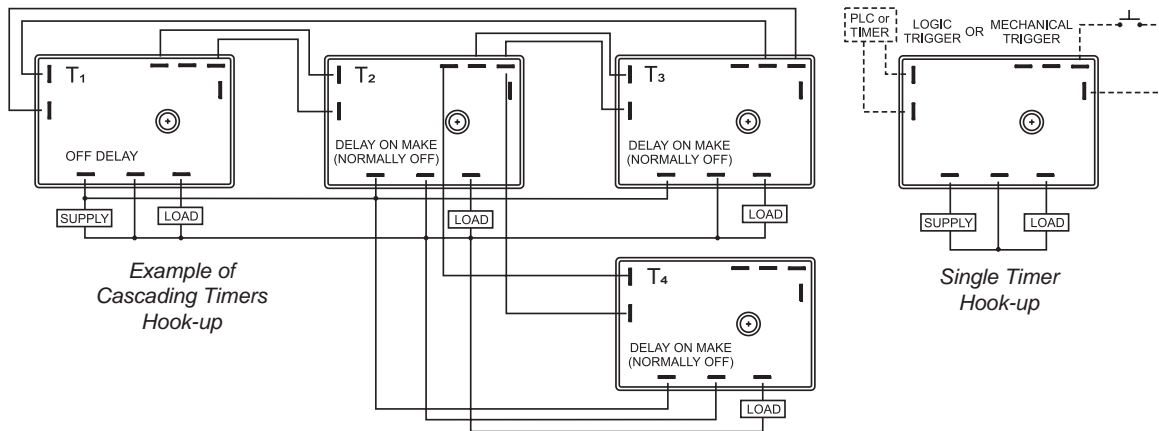

Technical Data

Input Voltage Range	12-240 VDC, 24-240 VAC (50/60 Hz)
Max. Output Current	1 Amp
Logic Trigger In	5-48 VDC (10k Input impedance)
Logic Trigger Out	5.5 V @ .55mA Max.
Mechanical Trigger In	80mA Max. Current draw
Transient Suppression	AC - MOV DC - Diode
Reset Time Max.	50ms
Repeat Accuracy	+/-0.1% or 10ms (whichever is greater)
Time Delay	+/-2% Variable over ambient temperature range
Ambient Temp. Range	-20° to +60°C
Materials	Housing: ABS Encapsulation: Epoxy
Environmental Protection	NEMA 1

Timer Programming

Switch Symbols
ON = ON
OFF = OFF

Chart 1	
#1 Delay Range (seconds) All Function	Switch Settings
.10 - 4.70	ON OFF
0.36 - 18.0	ON OFF
2.80 - 150	ON OFF
23.0 - 1200	ON OFF
Delay = range X 1	ON OFF
Delay = range X 100	ON OFF

Chart 2	
#2 Delay Range (seconds) Cycle Function Only	Switch Settings
0.10 - 4.70	ON OFF
0.36 - 18.0	ON OFF
2.80 - 150	ON OFF
23.0 - 1200	ON OFF
Delay = range X 1	ON OFF
Delay = range X 100	ON OFF

Chart 3	
Function	Switch Settings
#1 Off delay (retriggerable)	ON OFF
#2 On delay (retriggerable)	ON OFF
#3a Cycle (on first)	ON OFF
#3b Cycle (off first)	ON OFF
#4a Square wave (on first)	ON OFF
#4b Square wave (off first)	ON OFF
#5 Delay on break (normally off)	ON OFF
#6 Delay on break (normally on)	ON OFF
#7 Delay on make (normally off)	ON OFF
#8 Delay on make (normally on)	ON OFF
#9a Toggle (on first)	ON OFF
#9b Toggle (off first)	ON OFF

Operation

Mechanical Trigger Input - A switch closure at this input begins or resets the timing period of any non-cycling MBT function.

Logic Trigger Input - A sourcing or sinking voltage signal (5 - 48 volts) at this input begins or resets the timing period of any non-cycling MBT function.

Logic Trigger Outputs - The logic output produces a voltage signal in sync with the timing cycle. Timers can be cascaded when the logic output of one timer is connected to the logic input of other timers.

The logic signal output is inactive when power is initially applied to the timer. The #1 logic output produces a voltage level opposite the #2 logic output.

Cascading Multiple Timers - There is no limit to the number of MBTs that can be cascaded in series (the logic output of one MBT connected to the logic input of another MBT). However the number of parallel MBTs (the same logic output connected to the logic input of more than one other MBT) should be limited to 10 MBTs.

FUNCTION #1

Load is energized for ΔT upon application of power. Reset occurs when power is removed or trigger is applied.

Off Delay (Retriggerable)

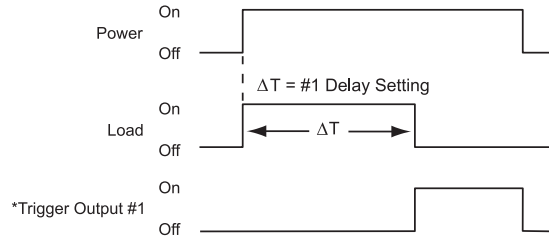

FUNCTION #2

Load remains Off for ΔT upon application of power. Reset occurs when power is removed or trigger is applied.

On Delay (Retriggerable)

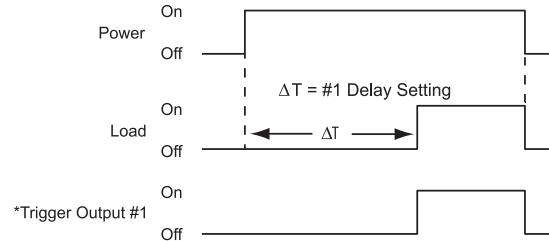

FUNCTION #3a / 3b

Load cycles ΔT_1 and ΔT_2 when power is applied. Reset occurs when power is removed.

Cycle

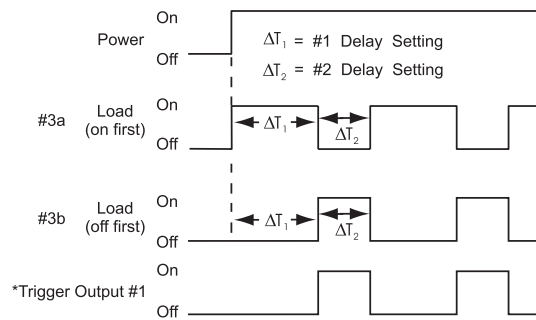

FUNCTION #4a / 4b

Load cycles with equal On and Off times when power is applied. Reset occurs when power is removed.

Square Wave

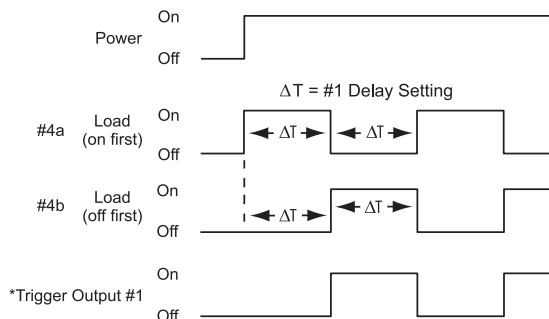

FUNCTION #5

When power is applied, load reins Off. Load is energized when trigger switch is closed. When trigger switch is opened, ΔT begins. The load de-energizes at completion of ΔT . Reset occurs when load is Off and trigger is re-applied.

Delay On Break (Normally Off)

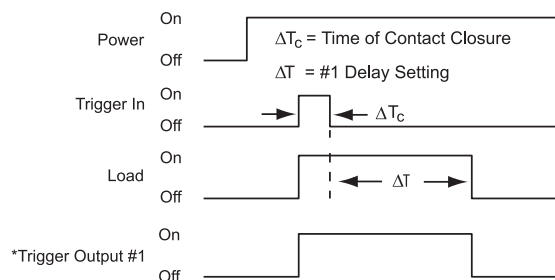

NOTE: Refer to charts on page 103 for switch settings.

*Trigger Output #2 level is always opposite of Trigger Output #1.

FUNCTION #6

When power is applied, load is energized and remains energized until the trigger switch is closed. Load is then Off for $\Delta T_c + \Delta T$. Reset occurs when load is On and the trigger is re-applied.

Delay On Break (Normally On)

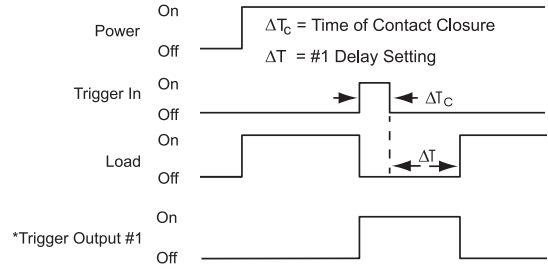

FUNCTION #7

When power is applied, load remains Off. Load is energized for ΔT only upon closure of a normally open momentary contact switch (trigger). Reset occurs when load is Off and the trigger switch is closed.

Delay On Make (Normally Off)

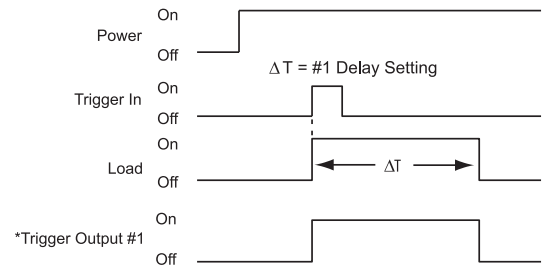

FUNCTION #8

When power is applied, load is energized. Load de-energizes for ΔT only upon closure of a normally open momentary contact switch (trigger). Reset occurs when load is On and the trigger switch is closed.

Delay On Make (Normally On)

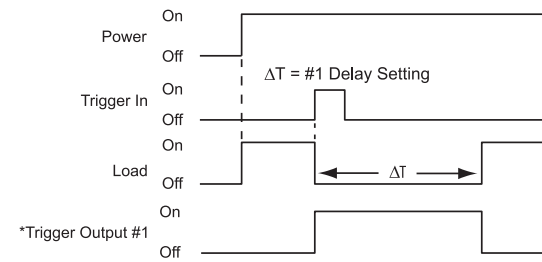

FUNCTION #9a / 9b

When power is applied, load is On. Load switches state (On/Off) with each application of trigger

Toggle

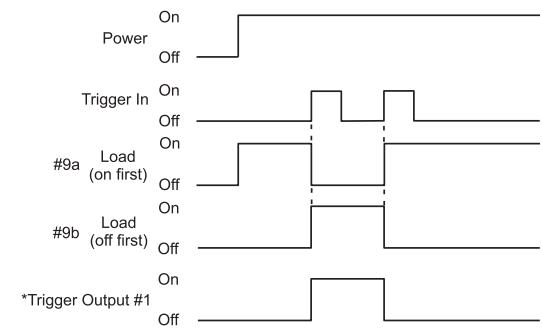

NOTE: Refer to charts on page 103 for switch settings.

*Trigger Output #2 level is always opposite of Trigger Output #1.

Ordering Information

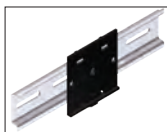

DIN Rail Mounting Adapter
 P/N: DRM-100

ORDER PART NUMBER
MBT-1000-00

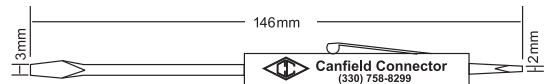

Optional Adjustment Tool
 P/N: 5000-TOOL

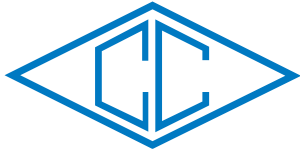

TMLT

**MICROLOGIC TIMER
MODULE**

General Description

The Canfield Connector TMLT is an ultra-compact all solid state timer incorporated into a vibration and environment resistant composite encapsulant housing. The heart of the timer is a powerful microprocessor that is made in quantity then programmed to become the timer type according to customer specification. Featuring 6 timer modes of operation with two voltage ranges; 12-240V AC/DC or 12-60 VDC and four output options; Sinking ON First, Sinking OFF First, Sourcing ON First, and Sourcing OFF First, and 13 time ranges, from 0.1 to 2000 seconds. The timer is available with screwdriver or hand adjustment, and troubleshooting is a breeze with the onboard indicator light. The TMLT is versatile as well as rugged, and each timer is 100% tested, made in America and resistant to dust, vibration and humidity. Mounting is accomplished by use of a through hole able to accommodate up to a 1/4" (6mm) screw or by use of a DIN rail mount adapter plate. Electrical connections are .250" AMP Faston posts for crimp type push-on connectors.

Dimensional Data

ALL DIMENSIONS ARE IN MILLIMETERS UNLESS OTHERWISE NOTED

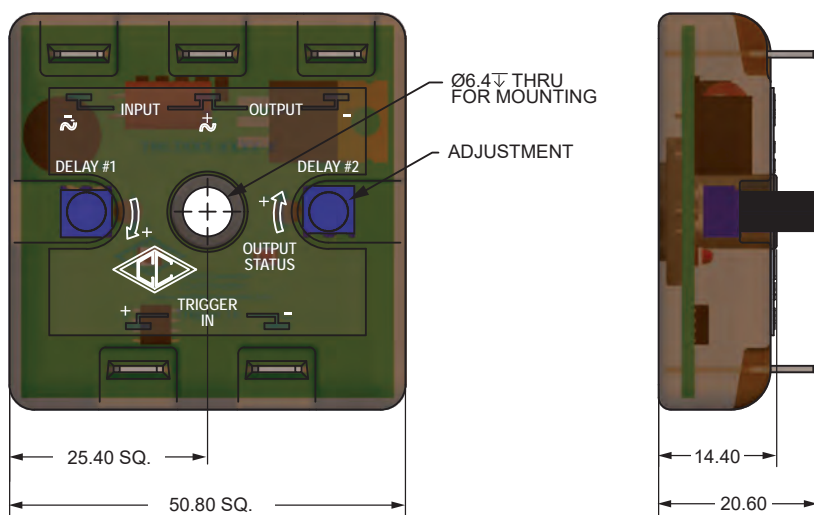
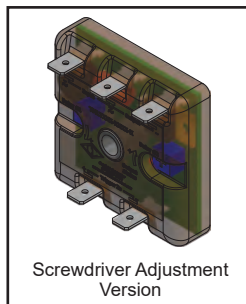
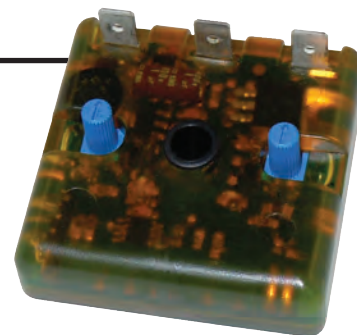

Technical Data

Max. Timer Current Draw	2 mA (no load)
Output Current Max.	1 Amp
Input Voltage Range	12-240V AC/DC, 50/60 Hz or 12-60 VDC
Logic Trigger Rated	5-48 VDC (10k input impedance)
Mechanical Trigger Rated	5 VDC, 1 mA max.
Repeat Accuracy	+/-0.1% or 10ms (whichever is greater)
Time Delay	+/- 5% (Variable over ambient temp. range)
Materials	Enclosure: Macromelt Thermoplastic Polyamide
Temp. Range	-20° to +60°C
Environmental Protection	NEMA 1

Timing Diagrams / Ordering Guide

SQUARE WAVE

Load cycles with equal ΔT_1 time when power is applied. Reset occurs when power is removed.

How To Order

TMLTSW - 00

ΔT_1

Voltage / Output Type

1 - 12-240V AC/DC / Sinking / On first
 2 - 12-240V AC/DC / Sinking / Off first
 3 - 12-60V DC / Sinking / On First
 4 - 12-60V DC / Sinking / Off First
 5 - 12-60V DC / Sourcing / On First
 6 - 12-60V DC / Sourcing / OFF First

Adjustable Potentiometer

0 - Screw Adjust
 1 - Hand Adjust

Time Range

A - 0.5 to 5 sec.	H - 5.0 to 50 sec.
B - 0.5 to 25 sec.	I - 5.0 to 500 sec.
C - 0.5 to 50 sec.	J - 10 to 100 sec.
D - 0.5 to 100 sec.	K - 10 to 1000 sec.
E - 2.0 to 20 sec.	L - 10 to 2000 sec.
F - 2.0 to 200 sec.	Z - 0.1 to 5 sec.
G - 2.0 to 400 sec.	

CYCLE

Load cycles ΔT_1 and ΔT_2 when power is applied. Reset occurs when power is removed.

How To Order

TMLTCY - 0

ΔT_1 ΔT_2

Voltage / Output Type

1 - 12-240V AC/DC / Sinking / On first
 2 - 12-240V AC/DC / Sinking / Off first
 3 - 12-60V DC / Sinking / On First
 4 - 12-60V DC / Sinking / Off First
 5 - 12-60V DC / Sourcing / On First
 6 - 12-60V DC / Sourcing / OFF First

Adjustable Potentiometer

0 - Screw Adjust
 1 - Hand Adjust

Time Range

A - 0.5 to 5 sec.	H - 5.0 to 50 sec.
B - 0.5 to 25 sec.	I - 5.0 to 500 sec.
C - 0.5 to 50 sec.	J - 10 to 100 sec.
D - 0.5 to 100 sec.	K - 10 to 1000 sec.
E - 2.0 to 20 sec.	L - 10 to 2000 sec.
F - 2.0 to 200 sec.	Z - 0.1 to 5 sec.
G - 2.0 to 400 sec.	

21

DELAY ON MAKE

When power is applied, load is on. Load is off for ΔT_1 once the trigger is applied. Reset occurs when load is on and the trigger is re-applied.

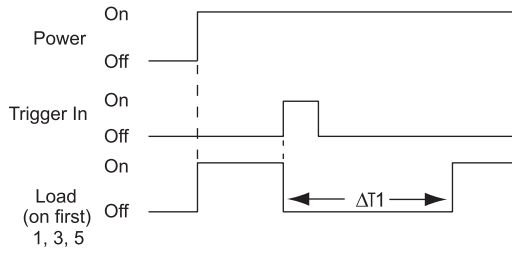

When power is applied, load is off. Load is on for ΔT_1 once the trigger is applied. Reset occurs when load is on and the trigger is re-applied.

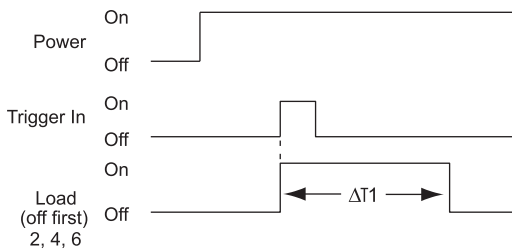

DELAY ON BREAK

When power is applied, load is on. Load is then off for $\Delta T_c + \Delta T_1$ when trigger is applied then removed. Reset occurs when load is on and the trigger is re-applied.

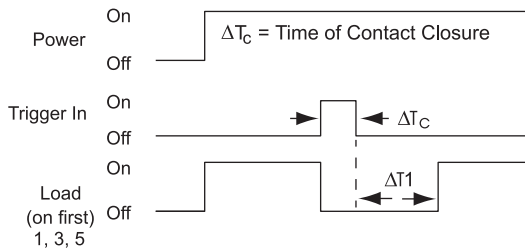

When power is applied, load is off. Load is on for $\Delta T_c + \Delta T_1$ when trigger is applied then removed. Reset occurs when load is on and the trigger is re-applied.

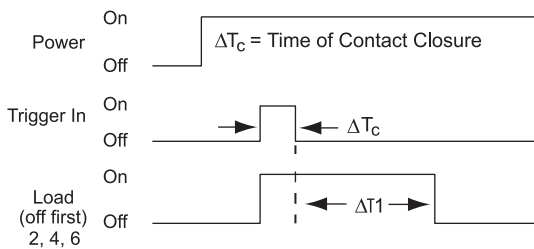

How To Order

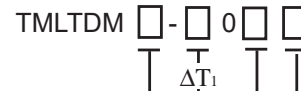

- Voltage / Output Type**
- 1 - 12-240V AC/DC / Sinking / On first
 - 2 - 12-240V AC/DC / Sinking / Off first
 - 3 - 12-60V DC / Sinking / On First
 - 4 - 12-60V DC / Sinking / Off First
 - 5 - 12-60V DC / Sourcing / On First
 - 6 - 12-60V DC / Sourcing / OFF First

- Adjustable Potentiometer**
- 0 - Screw Adjust
 - 1 - Hand Adjust

- Trigger Option**
- 1 - 5-48 Volt Trigger
 - 2 - Mechanical Trigger

- Time Range**
- | | |
|---------------------|---------------------|
| A - 0.5 to 5 sec. | H - 5.0 to 50 sec. |
| B - 0.5 to 25 sec. | I - 5.0 to 500 sec. |
| C - 0.5 to 50 sec. | J - 10 to 100 sec. |
| D - 0.5 to 100 sec. | K - 10 to 1000 sec. |
| E - 2.0 to 20 sec. | L - 10 to 2000 sec. |
| F - 2.0 to 200 sec. | Z - 0.1 to 5 sec. |
| G - 2.0 to 400 sec. | |

How To Order



- Voltage / Output Type**
- 1 - 12-240V AC/DC / Sinking / On first
 - 2 - 12-240V AC/DC / Sinking / Off first
 - 3 - 12-60V DC / Sinking / On First
 - 4 - 12-60V DC / Sinking / Off First
 - 5 - 12-60V DC / Sourcing / On First
 - 6 - 12-60V DC / Sourcing / OFF First

- Adjustable Potentiometer**
- 0 - Screw Adjust
 - 1 - Hand Adjust

- Trigger Option**
- 1 - 5-48 Volt Trigger
 - 2 - Mechanical Trigger

- Time Range**
- | | |
|---------------------|---------------------|
| A - 0.5 to 5 sec. | H - 5.0 to 50 sec. |
| B - 0.5 to 25 sec. | I - 5.0 to 500 sec. |
| C - 0.5 to 50 sec. | J - 10 to 100 sec. |
| D - 0.5 to 100 sec. | K - 10 to 1000 sec. |
| E - 2.0 to 20 sec. | L - 10 to 2000 sec. |
| F - 2.0 to 200 sec. | Z - 0.1 to 5 sec. |
| G - 2.0 to 400 sec. | |

DELAY (NON-TRIGGERABLE)

When power is applied, load is off. Load on after ΔT_1 . Reset occurs when power is removed

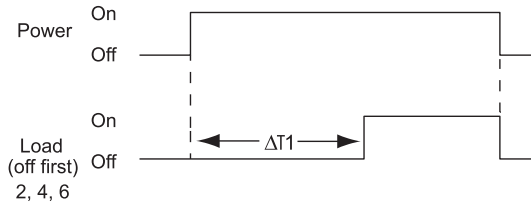

When power is applied, load is on. Load off after ΔT_1 . Reset occurs when power is removed

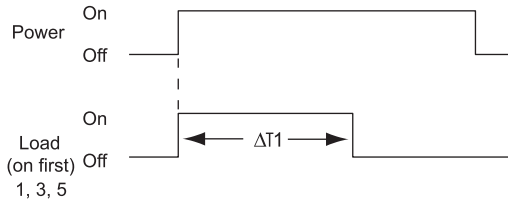

How To Order

TMLTDY - 00
 ΔT_1

Voltage / Output Type
 1 - 12-240V AC/DC / Sinking / On first
 2 - 12-240V AC/DC / Sinking / Off first
 3 - 12-60V DC / Sinking / On First
 4 - 12-60V DC / Sinking / Off First
 5 - 12-60V DC / Sourcing / On First
 6 - 12-60V DC / Sourcing / OFF First

Adjustable Potentiometer
 0 - Screw Adjust
 1 - Hand Adjust

Time Range

A - 0.5 to 5 sec.	H - 5.0 to 50 sec.
B - 0.5 to 25 sec.	I - 5.0 to 500 sec.
C - 0.5 to 50 sec.	J - 10 to 100 sec.
D - 0.5 to 100 sec.	K - 10 to 1000 sec.
E - 2.0 to 20 sec.	L - 10 to 2000 sec.
F - 2.0 to 200 sec.	Z - 0.1 to 5 sec.
G - 2.0 to 400 sec.	

SINGLE CYCLE

Solenoid cycles ΔT_1 and ΔT_2 when power is applied. Reset occurs when power is removed.

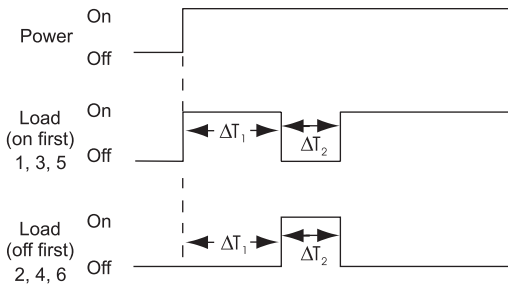

How To Order

TMLTSC - 0
 ΔT_1 ΔT_2

Voltage / Output Type
 1 - 12-240V AC/DC / Sinking / On first
 2 - 12-240V AC/DC / Sinking / Off first
 3 - 12-60V DC / Sinking / On First
 4 - 12-60V DC / Sinking / Off First
 5 - 12-60V DC / Sourcing / On First
 6 - 12-60V DC / Sourcing / OFF First

Adjustable Potentiometer
 0 - Screw Adjust
 1 - Hand Adjust

Time Range

A - 0.5 to 5 sec.	H - 5.0 to 50 sec.
B - 0.5 to 25 sec.	I - 5.0 to 500 sec.
C - 0.5 to 50 sec.	J - 10 to 100 sec.
D - 0.5 to 100 sec.	K - 10 to 1000 sec.
E - 2.0 to 20 sec.	L - 10 to 2000 sec.
F - 2.0 to 200 sec.	Z - 0.1 to 5 sec.
G - 2.0 to 400 sec.	

NOTE: Fixed and custom time ranges available. Consult factory or details.

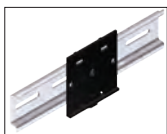

DIN Rail Mounting Adapter
 P/N: DRM-100

Ordering Example: TMLTSC1-AB00

12-240 AC/DC, Sinking, Single
 Cycle 1 (on first), 0.5 to 5 sec.,
 0.5 to 25 sec., Screw Adjust.

INDEX OF PROTECTION (IP) RATINGS (International Electrotechnical Commission Index of Protection)	NEMA STANDARDS (National Electrical Manufacturers Association)
PROTECTION AGAINST SOLID OBJECTS - FIRST DIGIT	ENCLOSURE TYPES FOR NON-HAZARDOUS LOCATIONS
<p>0 No Protection</p> <p>1 Protected from solid objects up to 50mm (e.g. accidental touch by hands)</p> <p>2 Protected from solid objects up to 12mm (e.g. accidental touch fingers)</p> <p>3 Protected from solid objects larger than 2.5mm (e.g. tools and small wires)</p> <p>4 Protected from solid objects larger than 1mm (e.g. small wires)</p> <p>5 Protected from dust; limited entrance (no harmful deposit)</p> <p>6 Totally protected from dust</p>	<p>Type 1 GENERAL PURPOSE Enclosures are intended for indoor use primarily to provide a degree of protection against contact with the enclosed equipment or locations where unusual service conditions do not exist.</p> <p>Type 2 DRIP TIGHT Enclosures are intended for indoor use primarily to provide a degree of protection against limited amounts of falling water and dirt.</p> <p>Type 3 WEATHERPROOF (Weather Resistant) Enclosures are intended for outdoor use primarily to provide a degree of protection against wind-blown dust, rain and sleet; undamaged by the formation of ice on the enclosure.</p>
PROTECTION AGAINST LIQUIDS - SECOND DIGIT	
<p>0 No Protection</p> <p>1 Protected from vertically falling drops of water (e.g. condensation)</p> <p>2 Protected from direct sprays of water up to 15° from vertical</p> <p>3 Protected from direct sprays of water up to 60° from vertical</p> <p>4 Protected from water sprayed from all directions; Limited entrance allowed</p> <p>5 Protected from low pressure jets of water from all directions; limited entrance allowed</p> <p>6 Protected from strong jets of water; limited entrance allowed (e.g. for use on ship decks)</p> <p>7 Protected from the effects of immersion between 15 cm and 1 m for 30 minutes</p> <p>8 Protected from extended periods of immersion under pressure</p>	<p>Type 3R RAIN TIGHT Enclosures are intended for outdoor use primarily to provide a degree of protection against falling rain and sleet; undamaged by the formation of ice on the enclosure.</p> <p>Type 4 WATERTIGHT Enclosures are intended for indoors and outdoors use primarily to provide a degree of protection against windblown dust and rain, splashing water and hose-directed water; undamaged by the formation of ice on the enclosure.</p> <p>Type 4X WATERTIGHT Enclosures are intended for indoors and outdoors use primarily to provide a degree of protection against corrosion, windblown dust and rain, splashing water and hose-directed water; undamaged by the formation of ice on the enclosure.</p> <p>Type 5 No NEMA equivalent.</p> <p>Type 6 SUBMERSIBLE Enclosures are intended for indoors and outdoors where occasional submersion is encountered.</p>
EXAMPLE - IP67	<p>Type 12 INDUSTRIAL USE Enclosures are intended for indoor and outdoor use primarily to provide a degree of protection against dust falling dirt, and dripping non-corrosive liquids.</p> <p>Type 13 DUSTPROOF Enclosures are intended for indoor and outdoor use primarily to provide a degree of protection against dust spraying of water, oil, and non-corrosive coolant.</p>
<p>6 Totally protected from dust</p> <p>7 Protected from the effects of immersion between 15 cm and 1 m for 30 minutes</p>	

Units and Conversion Factors

Metric to Standard Conversions

Millimeters (mm) x 0.03937	=	inches (") (in)
Centimeters (cm) x 0.3937	=	inches (") (in)
Meters (m) x 39.37	=	inches (") (in)
Meters (m) x 3.281	=	feet (') (ft)
Meters (m) x 1.094	=	yards (yds)
Kilometers (km) x 0.62137	=	miles (mi)
Kilometers (km) x 32.80.87	=	feet (') (ft)
Liters (l) x 0.2642	=	gallons (U.S.) (gals)
Liters (l) x 0.0353	=	cubic feet
Bars x 14.5038	=	pounds per square inch (PSI)
Kilograms (kg) x 2.205	=	pounds (P)
Kilometers (km) x 1093.62	=	yards (yds)
Square centimeters x 0.155	=	square inches
Square meters x 10.76	=	square feet
Square kilometers x 0.386	=	square miles
Cubic centimeters x 0.06102	=	cubic inches
Cubic meters x 35.315	=	cubic feet

Temperature

$^{\circ}\text{F} = (1.8 \times ^{\circ}\text{C}) + 32$

$^{\circ}\text{C} = 0.555 (^{\circ}\text{F} - 32)$

$^{\circ}\text{K} = ^{\circ}\text{C} + 273.2$

Fahrenheit	Celsius	Rankine	Kelvin
602	316.7	1061.7	589.9
572	300.0	1031.7	573.2
542	283.3	1001.7	556.5
512	266.7	971.7	539.9
482	250.0	941.7	523.2
452	233.3	911.7	506.5
422	216.7	881.7	489.9
392	200.0	851.7	473.2
362	183.3	821.7	456.5
332	166.7	791.7	439.9
302	150.0	761.7	423.2
272	133.3	731.7	406.5
342	116.7	701.7	389.9
212	100.0	671.7	373.2
182	83.3	641.7	356.5
152	66.7	611.7	339.9
122	50.0	581.7	323.2
92	33.3	551.7	306.5
62	16.7	521.7	289.9
32	0.0	491.7	273.2
2	-16.7	461.7	256.5
-28	-33.3	431.7	239.9
-58	-50.0	401.7	223.2
-88	-66.7	371.7	206.5
-118	-83.03	341.7	189.9
-148	-100.0	311.7	173.2
-178	-116.7	281.7	156.5
-208	-133.3	251.7	139.9
-238	-150.0	221.7	123.2
-268	-166.7	191.7	106.5
-298	-183.3	161.7	89.9
-328	-200.0	131.7	73.2
-358	-216.7	101.7	56.5
-388	-233.3	71.7	39.9
-418	-250.0	41.7	23.2
-459.7	-273.2	0.0	0.0

Variations of Ohms Law

Volts = $\sqrt{\text{Watts} \times \text{Ohms}}$
 Volts = $\frac{\text{Watts}}{\text{Amperes}}$
 Volts = Amperes x Ohms

Amperes = $\sqrt{\frac{\text{Watts}}{\text{Ohms}}}$
 Amperes = $\frac{\text{Watts}}{\text{Volts}}$
 Amperes = $\frac{\text{Volts}}{\text{Ohms}}$

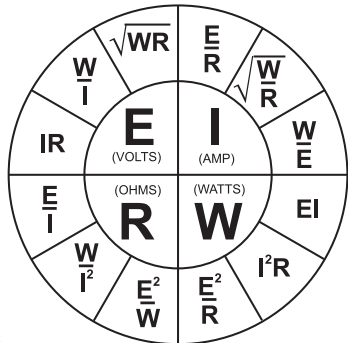

Ohms = $\frac{\text{Volts}}{\text{Amperes}}$
 Ohms = $\frac{\text{Volts}^2}{\text{Watts}}$
 Ohms = $\frac{\text{Watts}}{\text{Amperes}^2}$

Watts = $\frac{\text{Volts}^2}{\text{Ohms}}$
 Watts = Amperes² x Ohms
 Watts = Volts x Amperes

AC - Acronym for Alternating Current.

AMP (A) - Abbreviation of Ampere, a unit of measure for electrical current

AWG - American Wire Gage is a numerical standard used to refer to the diameter Wire Gaugeal area of a wire. Smaller numbers refer to larger Wire Gaugeal areas.

Bridge Rectifier - This is an electrical device made up of four diodes, which perform the function of full wave rectification (converts the full AC sine wave to DC).

Capacitor - This is an electronic device used to store an electric charge or to allow varying current to flow. The ideal capacitor will not allow steady state or DC current to flow. The capacitor is used in many applications including transient suppression, electrical noise filtering, timing circuits, etc.

Conductor - This is a material that can easily conduct (flow) electrical current. Metals are considered to be good conductors of electricity.

Current Surge - This is a short term (transient) condition causing a larger than normal amount of current to flow through a conductor. A current surge can often cause damage to an electrical device that is not properly protected.

DC - Acronym for Direct Current.

DIN - This is an acronym used for the Deutsches Institut fur Normung (German Standardization Institute).

DIN 43650 - A German standard stating the characteristics and requirements of connectors for magnetic valves used in hydraulics and pneumatics.

Diode - This is a solid state electronic component that allows current to flow in only one direction, similar to a check valve used in hydraulic or pneumatic applications. The diode is used in applications including transient suppression, power supply circuits etc.

Electronic Magnetic Sensor - This is a solid state device used to sense a magnetic field. Canfield Connector uses magneto-resistive sensors on all electronic magnetic sensors.

Gauss (Ga) - Unit of measure for magnetic flux density.

Ground - This term is used to define an electrical connection normally common to the chassis of a device or earth ground.

Hertz (Hz) - The unit of measure for frequency in cycles per second.

IP65 - An environmental protection rating of enclosures according to the German Standard DIN 40050.

ISO - This is an acronym used for the International Standards Organization.

LED - An acronym for Light Emitting Diode. A solid state diode which emits light when current passes through it in the proper direction.

MOV - An acronym for Metal Oxide Varistor. A solid state device used to suppress voltage surges/spikes.

NEMA - An acronym for National Electric Manufacturers As-sociation.

Nitrile (Buna) - This is a rubber-like man-made material used extensively in gasket and sealing applications.

Normally Closed - The state of the output or switch is ON with no external influence.

Normally Open - The state of the output or switch is OFF with no external influence.

NPN (Sinking) - Acronym used to describe the polarization of bipolar junction transistors (BJTs). Also associated with a sinking output.

Opto-Coupled - Refers to a technique used to optically activate (turn on) an electronic device, usually a transistor or triac, and physically separate two sides of a circuit. This action is similar to a solenoid relay. The typical opto-coupler incorporates an LED (light emitting diode) as the actuating device.

Parallel Magnet Polarity - The term used to describe the polar orientation of the piston magnet with respect to the cylinder stroke. In this case, the north and south poles are oriented in the same direction parallel to the cylinder stroke.

Perpendicular Magnet Polarity - The term used to describe the polar orientation of the piston magnet with respect to the cylinder stroke. In this case, the north and south poles are oriented perpendicular to the cylinder stroke.

PNP (Sourcing) - Acronym used to describe the polarization of bipolar junction transistors (BJTs). Also associated with a sourcing output.

Rectification - This is a term used to describe an electrical process which converts AC (alternating current) to DC (direct current).

Reed Switch - This is a miniature mechanical switch that changes state when a magnetic field is applied.

Resistor - This is an electronic device that resists the flow of current. Higher resistor Ohm values offer more resistance to the flow of current.

Silicone - This is a rubber-like man-made material used extensively in gasket and sealing applications. It is very resistant to a wide range of chemicals including oils and solvents, and has a very wide temperature range.

Sinking - The term is used here to describe the way a switch is connected in the circuit. If the switch completes the electrical circuit by connecting the load to ground/(-), it is considered to be sinking the load. In a solid state device this is equivalent to a NPN output.

Solid State - This is a term often used to describe an electronic device made up of solid components (no moving parts).

Sourcing - The term is used here to describe the way a switch is connected in the circuit. If the switch completes the electrical circuit by connecting the load to the positive/(+), it is considered to be sourcing the load. In a solid state device this is equivalent to a PNP output.

SPST - Acronym used for Single Pole Single Throw switches.

SPDT - Acronym used for Single Pole Double Throw switches.

Transistor - This is a solid state device used in electronic circuits. It is often used in switching or amplifier applications.

Triac - This is a solid state device often used to switch AC voltage/ current.

Volt (V) - The unit of measure for electrical potential.

Voltage Spike - This is a short term (transient) condition causing a larger than normal amount of voltage to be applied to a circuit. Voltage spikes can often cause damage to an electric device that is not properly protected.

Watt (W) - The unit of measure for electrical power.

Notes

We appreciate your business!

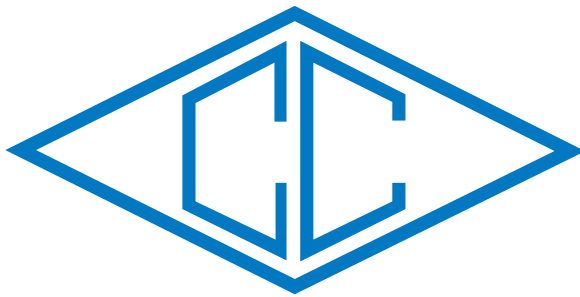

canfield connector

8510 Foxwood Court ♦ Youngstown, OH 44514

1-800-554-5071

Ph:(330)758-8299 ♦ Fx:(330)758-8912

www.canfieldconnector.com

